

# ASO: The air flow giant.

At 60 Hz, the ASO delivers 15900 l/min when used with the appropriate accessories it can supply several Leister air heaters in parallel.

## Medium pressure blower

### ASO



#### Technical data ASO

Design: radial blower

Frequency	Hz	50	60
Air flow (20 °C)	l/min	13500	15900
Static pressure	kPa	1.6	2.4
Max ambient temperature	°C	60	60
Max. air inlet temperature	°C	200	200
Noise emission level	dB(A)	70	70
Environmental protection (IEC 60529)		IP 54	IP 54
Outside diameter air inlet	mm	Ø 134	Ø 134
Outside diameter air outlet	mm	Ø 90	Ø 90
Weight	kg	15.0	15.0
Mark of conformity		CE	CE
Protection class I		⊕	⊕

#### Installation dimensions in mm

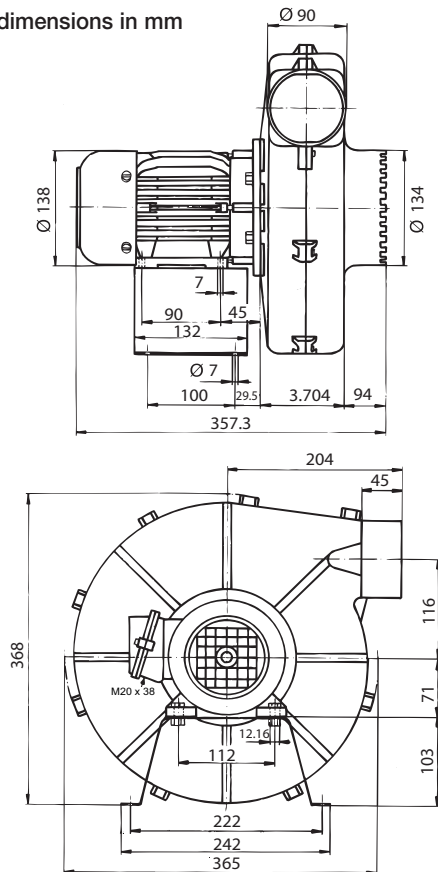



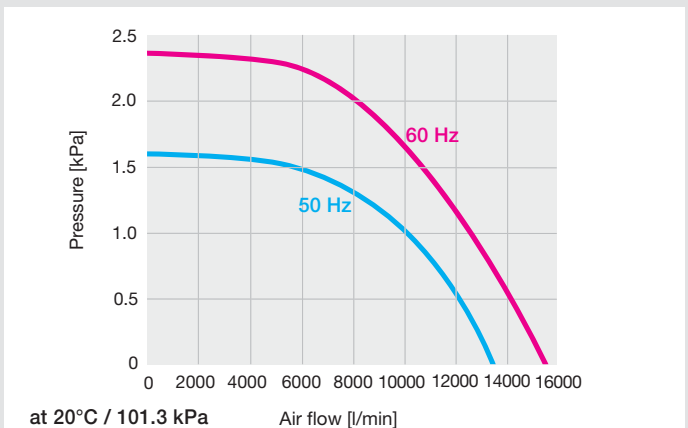

Voltage	V~ 50Hz	1 × 230	3 × 230 / 400
	60Hz		3 × 440 – 480
Power consumption	W	550	550
<b>Without cable</b>	<b>Order no.</b>		<b>103.527</b>
<b>3 m cable / Euro plug</b>	<b>Order no.</b>	<b>103.530</b>	

Additional versions available on request



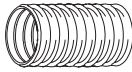

→ Accessories page 60

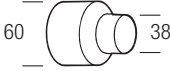
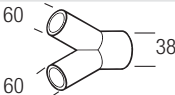
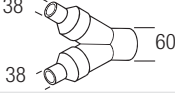
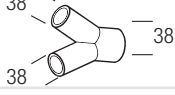
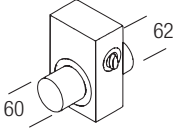
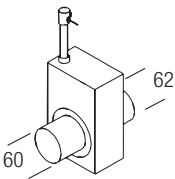

## Accessories SILENCE (Ø 60 mm)

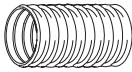
107.288		PVC air hose Ø 60 mm
107.287		Hose clip for Ø 60 mm air hose
107.240		Closing cap Ø 60 mm in attachable to hose connection adaptor 107.238 and 107.278
107.294		Stainless steel filter, push-fit on air intake
110.887		Motor capacitor 230 V
107.291		Hose connection adaptor with 1 air outlet for Ø 38 mm hose. Push-fit on air outlet
107.278		Hose connection adaptor, Push-fit on air outlet
107.292		Hose connection adaptor with 2 air outlets for Ø 38 mm hose. Push-fit on air outlet
107.293		Hose connection adaptor, Push-fit on adaptor 107.292
107.295		Hand operated air flow adjuster and on/off switch. Size 214 x 88 x 133 mm
107.296		Air flow off/on switch The air flow is interrupted on command (pneumatic 500 kPa) to the heaters. Size 214 x 88 x 133 mm

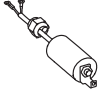
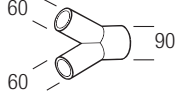
## Accessories ASO (Ø 90 mm)

107.237		PVC air hose Ø 90 mm
107.236		Hose clip for Ø 90 mm air hose
107.239		Stainless steel filter, push-fit on air intake
111.771		Motor capacitor 230 V
107.238		Hose connection adaptor, Push-fit

## Accessories MONO (Ø 38 mm)

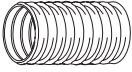
133.067		Holder
124.503		External air hose connection adaptor a = 64 mm, b = 38 mm
107.288		PVC air hose, Ø 60 mm

### Special nozzles on request

If using non-Leister blowers or accessories, Leister does not provide any warranty for its products.