

SILENCE: The quieter option.

No blower no air! In industrial processes one blower can often supply several air heaters in parallel. Our durable and maintenance-free blowers are a result of uncompromising quality standards and decades of experience. The mid-range blower SILENCE is very quiet during operation at 61 dB(A). It delivers high air flows and can be installed in all orientations.

Medium pressure blower

SILENCE



Technical data SILENCE

Design: radial blower			
Frequency	Hz	50	60
Air flow (20 °C)	l/min	4700	6000
Static pressure	kPa	1.0	1.4
Max ambient temperature	°C	60	60
Max. air inlet temperature	°C	200	200
Noise emission level	dB(A)	61	61
Environmental protection (IEC 60529)		IP 54	IP 54
Outside diameter air inlet	mm	Ø 80	Ø 80
Outside diameter air outlet	mm	Ø 60	Ø 60
Weight	kg	9.0	9.0
Mark of conformity		CE	CE
Protection classe I		⊕	⊕

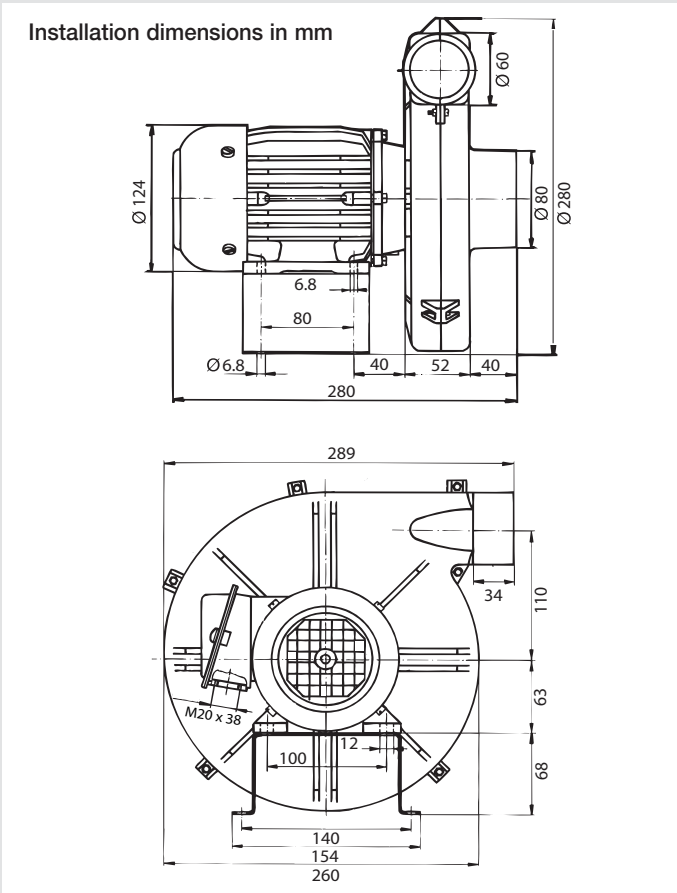



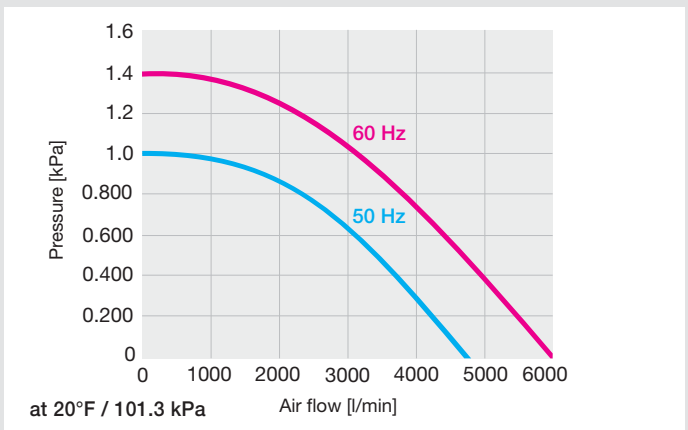

Voltage	V~ 50Hz	1 x 230	3 x 230 / 400
	60Hz		3 x 440 – 480
Power consumption	W	250	250
Without cable	Order no.		103.507
3 m cable / Euro plug	Order no.	103.510	

Additional versions available on request



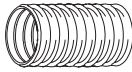

➔ Accessories page 60

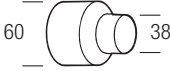
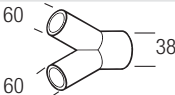
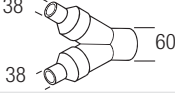
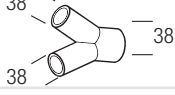
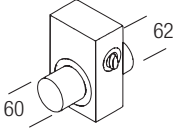
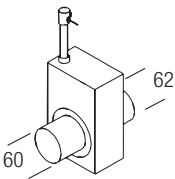

Accessories SILENCE (Ø 60 mm)

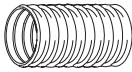
107.288		PVC air hose Ø 60 mm
107.287		Hose clip for Ø 60 mm air hose
107.240		Closing cap Ø 60 mm in attachable to hose connection adaptor 107.238 and 107.278
107.294		Stainless steel filter, push-fit on air intake
110.887		Motor capacitor 230 V
107.291		Hose connection adaptor with 1 air outlet for Ø 38 mm hose. Push-fit on air outlet
107.278		Hose connection adaptor, Push-fit on air outlet
107.292		Hose connection adaptor with 2 air outlets for Ø 38 mm hose. Push-fit on air outlet
107.293		Hose connection adaptor, Push-fit on adaptor 107.292
107.295		Hand operated air flow adjuster and on/off switch. Size 214 x 88 x 133 mm
107.296		Air flow off/on switch The air flow is interrupted on command (pneumatic 500 kPa) to the heaters. Size 214 x 88 x 133 mm

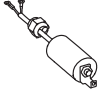
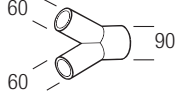
Accessories ASO (Ø 90 mm)

107.237		PVC air hose Ø 90 mm
107.236		Hose clip for Ø 90 mm air hose
107.239		Stainless steel filter, push-fit on air intake
111.771		Motor capacitor 230 V
107.238		Hose connection adaptor, Push-fit

Accessories MONO (Ø 38 mm)

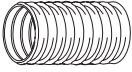
133.067		Holder
124.503		External air hose connection adaptor a = 64 mm, b = 38 mm
107.288		PVC air hose, Ø 60 mm

Special nozzles on request

If using non-Leister blowers or accessories, Leister does not provide any warranty for its products.